

TEHNIČKI LIST

# KOLJENO KVADRATNO 72°

WH-WKH

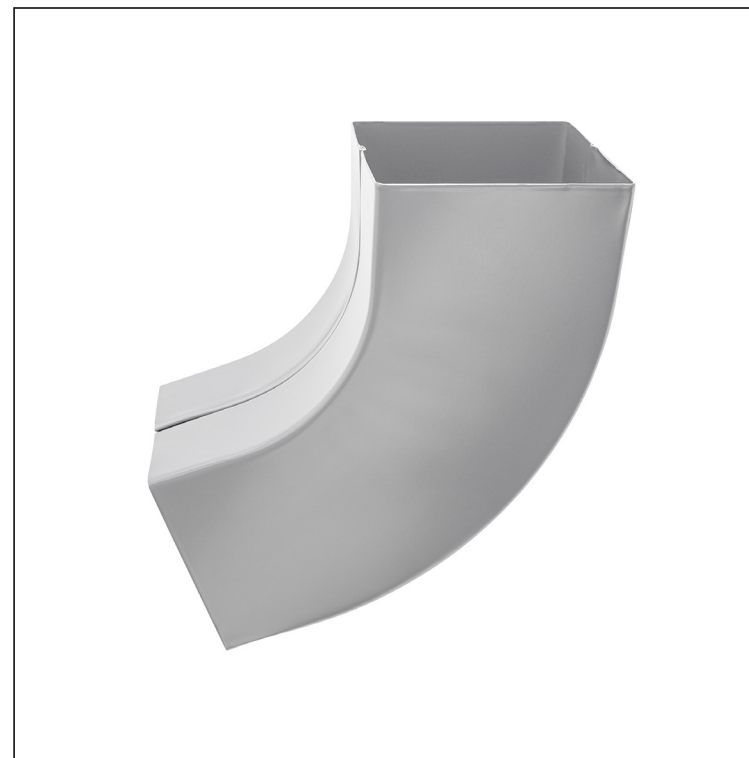

**BH** Aluminij obojeni – Srebrna – RAL 9006

Dimenzije [mm]			
Nominalna veličina	AxA	A1xA1	L
80/80	78 x 78	83 x 83	210
100/100	98 x 98	103 x 103	270

INDEX	ZAMIJENA	DATUM	POTPIS			
VRSTA MATERIJALA	RAZRED OTRPADA	TEŽINA kg	RAZMJER			
DIMENZIJA – POLUPROIZVOD						
POMOĆNA OPREMA		STN			OZNAKA ZA SORTIRANJE	
IZRADIO Ing. Kluska M.					BILJEŠKA	REDNI BROJ POZICIJE
TESTIRAO						
TEHNOLOG	TEHNOLOG			STARI NACRT		BROJ NACRTA
NAZIV PROIZVODA	Koljeno kvadratno 72°			Broj stranica	WH-WKH	Stranica 

Izrađeno: 07.06.2026 12:02:34

Podaci su podložni tehničkim promjenama

TEHNIČKI LIST

# KOLJENO KVADRATNO 72°

WH-WKH

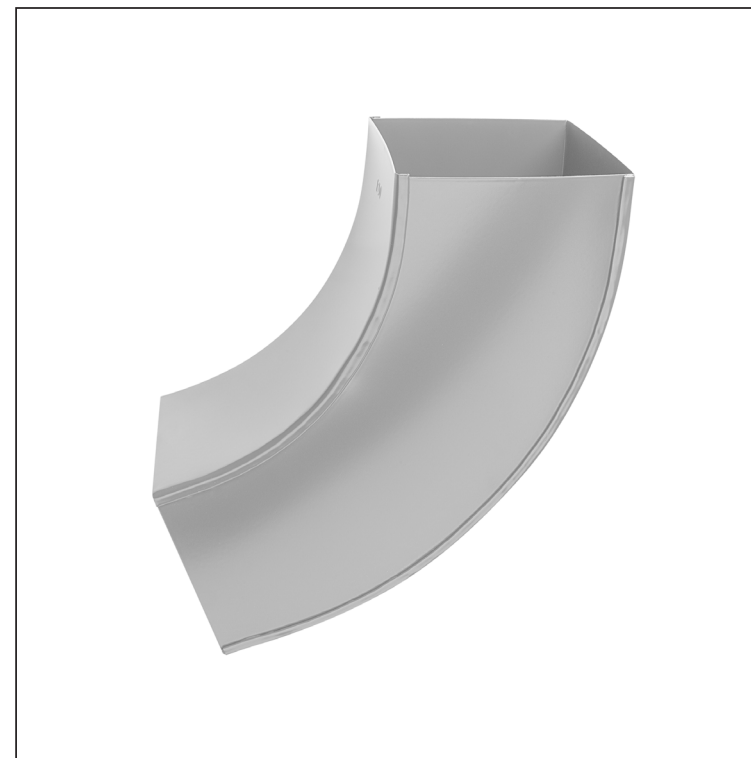

**BH** Aluminij obojeni – Srebrna – RAL 9006

INDEX	ZAMIJENA	DATUM	POTPIS		
VRSTA MATERIJALA			RAZRED OTPADA	TEŽINA kg	RAZMJER
DIMENZIJA – POLUPROIZVOD					
POMOĆNA OPREMA				STN	OZNAKA ZA SORTIRANJE
IZRADIO	Ing. Kluska M.			BILJEŠKA	REDNI BROJ POZICIJE
TESTIRAO					
TEHNOLOG		TEHNOLOG		STARI NACRT	BROJ NACRTA
NAZIV PROIZVODA				WH-WKH	
Koljeno kvadratno 72°				Broj stranica	Stranica 

Izrađeno: 07.06.2026 12:02:34

Podaci su podložni tehničkim promjenama

Dimenzije [mm]			
Nominalna veličina	AxA	A1xA1	L
120/120	118 x 118	123 x 123	300